

...you'll never drive alone

www.j4europe.com



MAN

suitable for

QTC® QUALITY
TRUCK
COMPONENTS

EDITION 2024

TGX 2013
TGS 2013
TGX 2007 - 2012
TGS 2007 - 2012
TGA XL-XXL
TGA M-L-LX
F2000
TGL
LE2000

page 3
page 6
page 9
page 11
page 12
page 18
page 23
page 28
page 29





M6X/200

M6X/232 RH



M6X/233 LH



M6X/111

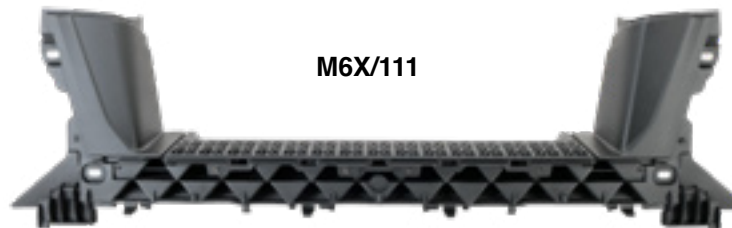

M6X/115



M6X/115G

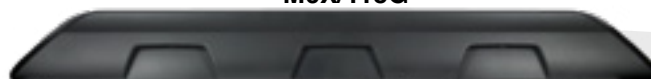

SUITABLE FOR **MAN TGX 2013**

M6X/108 RH



M6X/109 LH



M6X/106 RH



M6X/106G RH



**MTX/708 RH
MTX/708M RH**



**MTX/709 LH
MTX/709M LH**



M6X/107G LH



M6X/107 LH



M6X/102 RH



M6X/102G RH



M6X/103G LH



M6X/103 LH



M6X/102B RH



M6X/102BG RH



M6X/103BG LH



M6X/103B LH



SUITABLE FOR **MAN TGX 2013**

M6X/108 RH



M6X/109 LH

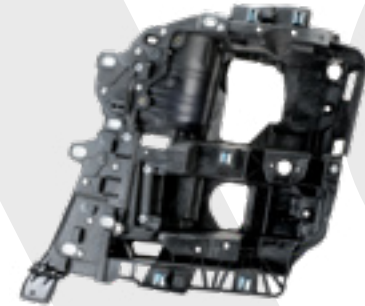

M6X/104 RH



M6X/104G RH



M6X/105G LH



M6X/105 LH



M6X/122 KIT

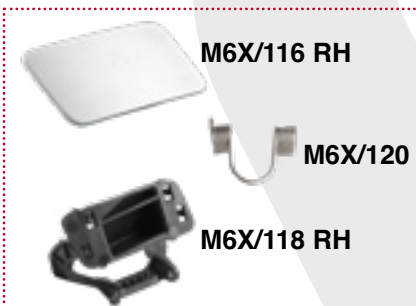

M6X/122G KIT

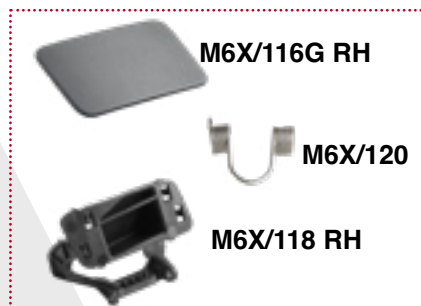

M6X/123G KIT



M6X/123 KIT





M6S/200



M6S/232 RH



M6S/233 LH



M6S/111



M6S/115



M6S/115G



SUITABLE FOR **MAN TGS 2013**

M6X/108 RH



M6X/109 LH



M6S/106 RH



M6S/106G RH



**MTX/708 RH
MTX/708M RH**



**MTX/709 LH
MTX/709M LH**



M6S/107G LH



M6S/107 LH



M6S/102 RH



M6S/102G RH



M6S/103G LH



M6S/103 LH



M6S/102B RH



M6S/102BG RH



M6S/103BG LH



M6S/103B LH



M6X/108 RH



M6X/109 LH



M6S/104 RH



M6S/104G RH

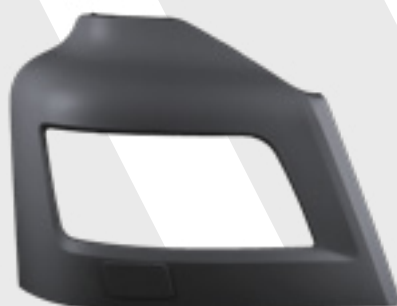

M6S/105G LH

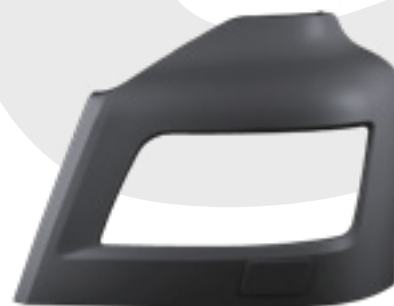

M6S/105 LH



M6X/122 KIT

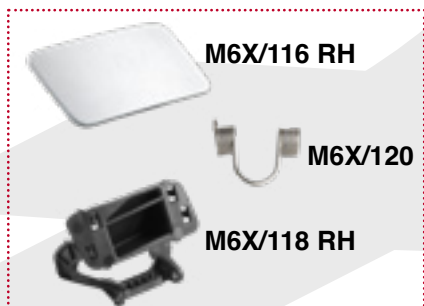

M6X/122G KIT

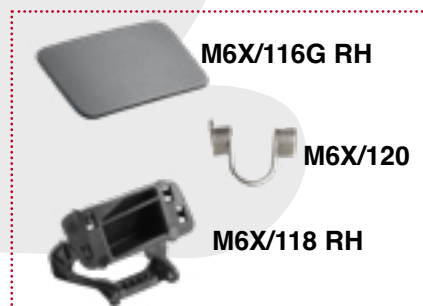

M6X/123G KIT



M6X/123 KIT



SUITABLE FOR **MAN TGX 2007 - 2012**



**MTX/180 GREY
MTX/180K KIT**



MTX/710 RH



MTX/711 LH



MTX/100K kit

MTX/100

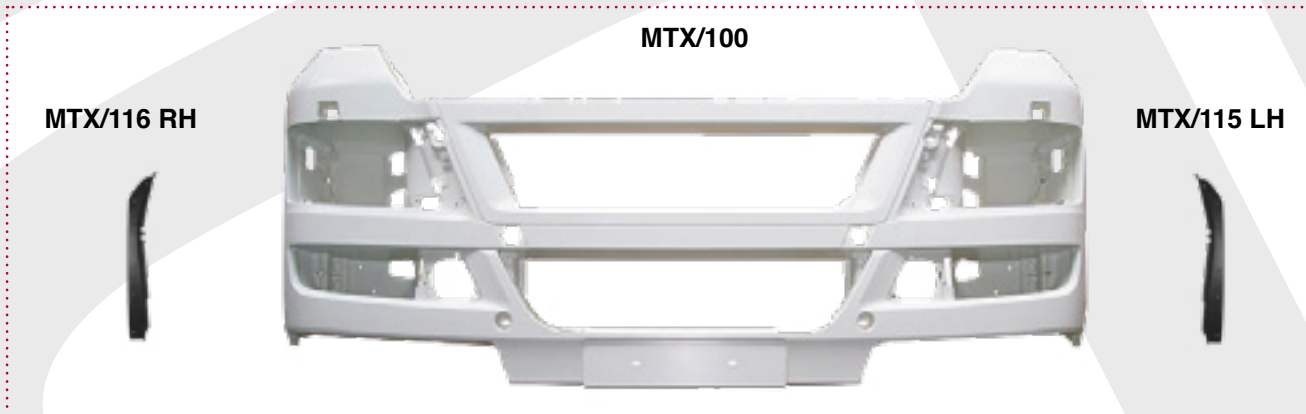

MTX/116 RH



MTX/115 LH



**MTX/706 RH
MTX/706X RH (XENON)
MTX/708 RH
MTX/708M RH**



**MTX/707 LH
MTX/707X LH (XENON)
MTX/709 LH
MTX/709M LH**



MTX/722 RH



MTX/723 LH



MTX/730 RH



MTX/731 LH



MXX/183



MXX/183



MTX/182 RH



MTX/181 LH



SUITABLE FOR **MAN TGX 2007 - 2012**



MTX/374 RH



MTX/375 LH



MTX/300 RH



MTX/301 LH



MTX/311 RH - LH



MTX/304 RH



MTX/305 LH



MTX/309 RH - LH



SUITABLE FOR **MAN TGS 2007 - 2012**



MTS/350 RH



MXX/356



MTS/351 LH



MTS/182 RH



MTS/181 LH



SUITABLE FOR **MAN TGA XL - XXL 2002 - 2007**

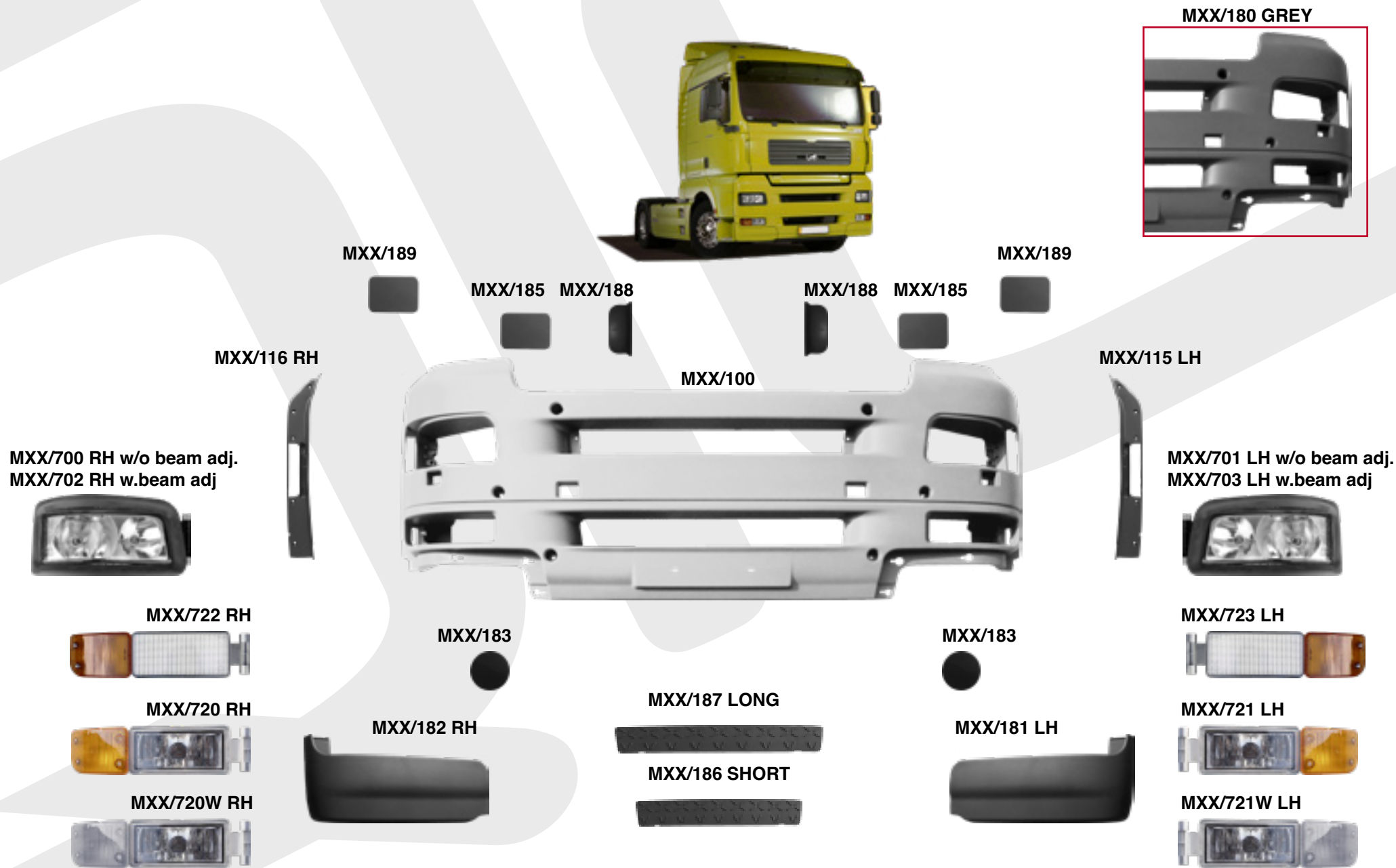

SUITABLE FOR **MAN TGA XL - XXL 2002**



MXX/260 RH



MXX/261 LH



MXX/201



MXX/262 RH



MXX/263 LH



MXX/264 RH



MXX/265 LH



MXX/200



MXX/216



MXX/217



SHINY CHROMED VERSION

SUITABLE FOR **MAN TGA XL - XXL 2002**



MXX/302 RH



MXX/303 LH



MXX/306 RH GREY



MXX/307 LH GREY



MXX/304 RH



MXX/305 LH

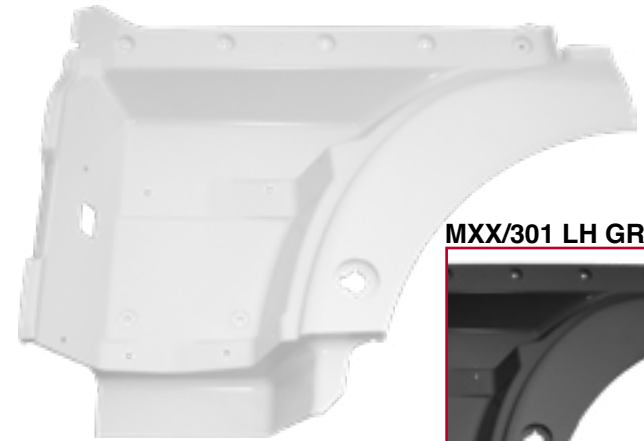

MXX/300 RH GREY

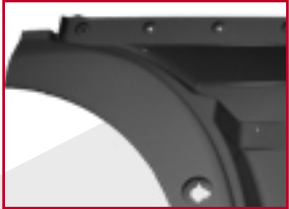

MXX/301 LH GREY



MXX/308 RH-LH



MXX/309 RH-LH



SUITABLE FOR **MAN TGA XL - XXL 2002**



MXX/355



MXX/350 RH

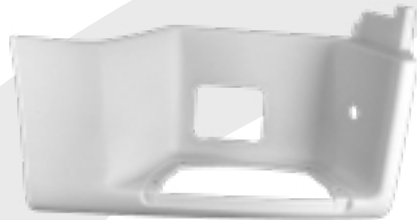

MXX/351 LH

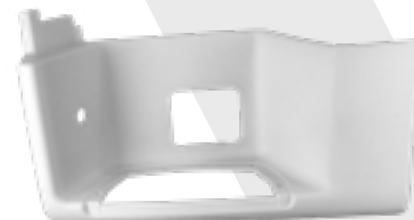

MXX/310 RH-LH

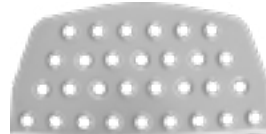

MXX/352 RH GREY



MXX/353 LH GREY



MXX/356



SUITABLE FOR **MAN TGA XL - XXL 2002**

MXX/370G RH



MXX/370 RH



MXX/371G LH



MXX/371 LH



MXX/360 RH-LH

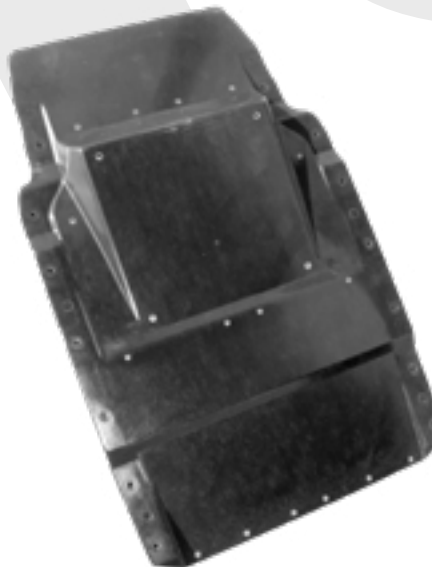

MXX/362G RH



MXX/362 RH



MXX/363 LH



MXX/363G LH



SUITABLE FOR **MAN TGA XL - XXL / TGX / TGS**

MTX/400



MTX/415



MXX/415



MXX/400

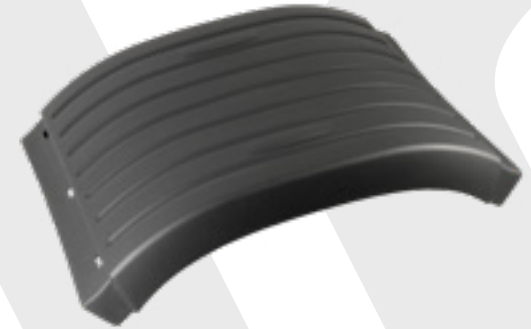

MTX/400WS WITH TENSIONERS



MTX/402 RH - LH *



MTX/402 REAR VIEW



MXX/400WS WITH TENSIONERS



MTX/401 RH - LH *



MTX/475



MTX/445 H 95 cm



MXX/402 LH-RH FRONT/REAR

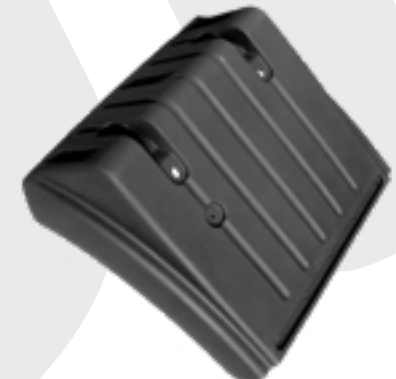

MXX/403 LH-RH FRONT/REAR

* MTX/475 INCLUDED

SUITABLE FOR **MAN Yard and quarry**



MXX/101



MXX/102 RH



MXX/103 LH



SUITABLE FOR **MAN TGA M - L - LX 2002**



MML/180 GREY

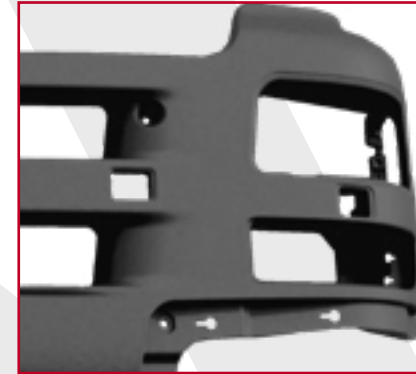

MML/100



MML/116 RH



MML/115 LH



MML/182 RH



MML/186



MML/181 LH



SUITABLE FOR **MAN TGA M - L - LX 2002**



MML/352 RH

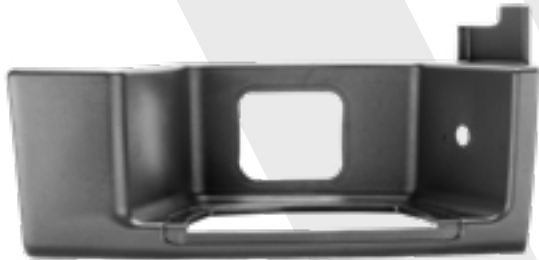

MML/353 LH



MML/356



MXX/310 RH-LH

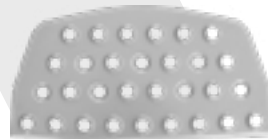

MML/350 RH



MML/351 LH



MML/355



SUITABLE FOR **MAN TGA M - L - LX 2002**



MML/300 RH



MML/301 LH



MML/302 RH



MML/303 LH



MML/304 RH



MML/305 LH



MXX/309



MML/306 RH



MML/307 LH



SUITABLE FOR **MAN TGA M - L - LX 2002**



MML/322 RH



MML/323 LH



MML/302 RH



MML/303 LH



MML/324 RH



MML/325 LH



MXX/309



MML/306 RH



MML/307 LH



SUITABLE FOR **MAN F2000 1994**

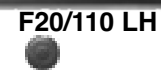
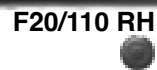
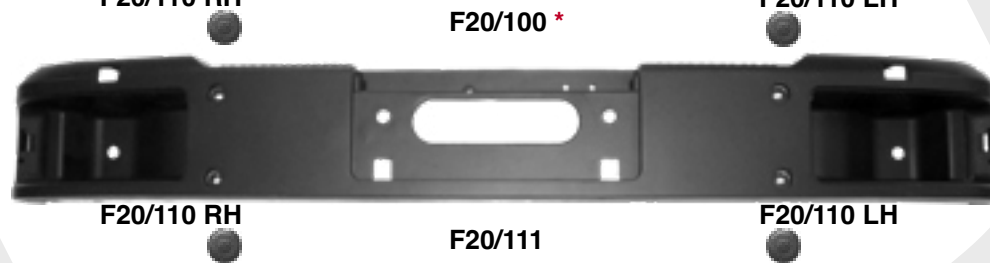
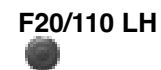
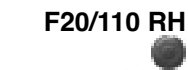

* F20/111 - 112 - 113 - 114 - 115 - 116 INCLUDED

SUITABLE FOR **MAN F2000** 1994



F20/105



F20/130



F20/146 RH

F20/104

F20/147 LH



F20/122 RH

F20/123 LH



F20/142 RH

F20/102

F20/143 LH



SUITABLE FOR **MAN F2000 1994**



F20/378 RH



F20/377 LH



F20/401 RH



F20/305 RH



F20/304 LH



F20/402 LH



F20/300 RH



F20/301 LH



F20/358 RH



F20/351 RH



F20/350 LH



F20/357 LH



F20/364 RH



F20/355 RH



F20/354 LH



F20/363 LH



F20/311 RH



F20/310 LH



F20/312 RH

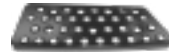

F20/313 LH

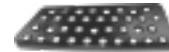

F20/316



F20/317



F20/315



SUITABLE FOR **MAN F2000 1994**

F20/386 RH



BACK AND FRONT VIEW

F20/382 RH



F20/384 RH-LH



F20/371 RH-LH



set of two outer handles with keys

F20/369 LH



F20/381 RH



F20/399 LH



F20/389 LH



F20/376 LH-RH



F20/373 LH F20/395 RH-LH



F20/398 RH



F20/388 RH

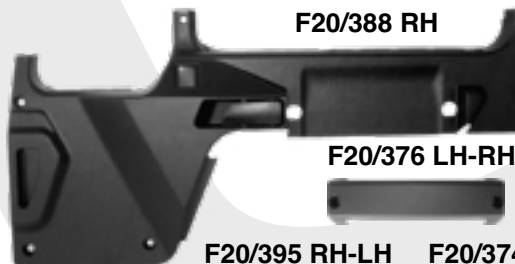

F20/376 LH-RH



F20/395 RH-LH



F20/374 RH



F20/380 LH



F20/368 RH



F20/385 LH



BACK AND FRONT VIEW

F20/383 LH



F20/384 RH-LH



SUITABLE FOR **MAN F2000 1994**



F20/262 RH



F20/260 RH



F20/205 RH



F20/500



F20/205 LH



F20/261 LH



F20/263 LH



F20/201



F20/CH6



F20/200

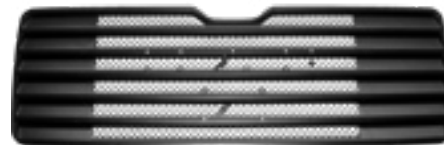

F20/CH2



F20/CH3



F20/CH5



SUITABLE FOR **MAN TGL 2005**



MTL/300 RH



MTL/301 LH



MTL/100



MXX/310

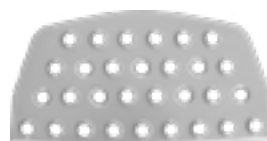

MML/186



SUITABLE FOR **MAN LE 2000 1992**



L20/300 RH



L20/301 LH



LE2/180



MAN TGX 2013

QTC®	OEM	PAG
M6X/102	81416106754	4
M6X/102G	81416106774	4
M6X/102B	81416106756	4
M6X/102BG	81416106776	4
M6X/103	81416106755	4
M6X/103G	81416106775	4
M6X/103B	81416106757	4
M6X/103BG	81416106777	4
M6X/104	81416106752	5
M6X/104G	81416106772	5
M6X/105	81416106753	5
M6X/105G	81416106773	5
M6X/106	81416106750	4
M6X/106G	81416106770	4
M6X/107	81416106751	4
M6X/107G	81416106771	4
M6X/108	81416106760 - 81416106968	4 - 5
M6X/109	81416106759 - 81416106969	4 - 5
M6X/111	81416146011	3
M6X/115	81416140076	3
M6X/115G	81416140080	3
M6X/116	81416100532	5
M6X/116G	81416100532	5
M6X/117	81416100533	5
M6X/117G	81416100533	5
M6X/118	81416100575	5
M6X/119	81416100744	5
M6X/120	81976300196	5
M6X/122		5
M6X/122G		5
M6X/123		5
M6X/123G		5
M6X/200	81416106951	3
M6X/232	81416100714	3
M6X/233	81416100713	3
MTX/708	81251016762	4
MTX/708M	81251016772 - 81251016760	4
MTX/709	81251016763	4
MTX/709M	81251016771 - 81251016759	4

MAN TGS 2013

QTC®	OEM	PAG
M6S/110	81416146010	6
M6S/102	81416106766	7
M6S/102G	81416106802	7
M6S/102B	81416106768	7
M6S/102BG	81416106804	7
M6S/103	81416106765	7
M6S/103G	81416106803	7
M6S/103B	81416106767	7
M6S/103BG	81416106805	7
M6S/104	81416106764	8
M6S/104G	81416106763	8
M6S/105	81416106800	8
M6S/105G	81416106801	8
M6S/106	81416106762	7
M6S/106G	81416106798	7
M6S/107	81416106761	7
M6S/107G	81416106799	7
M6S/111	81416146012	6
M6S/115	81416140077 - 81416146008	6
M6S/115G	81416140081	6
M6S/200	81416106956	6
M6S/232	81416100716	6
M6S/233	81416100715	6
M6X/108	81416106760	7 - 8
M6X/109	81416106759	7 - 8
M6X/116	81416100532	8
M6X/116G	81416100532	8
M6X/117	81416100533	8
M6X/117G	81416100533	8
M6X/118	81416100575	8
M6X/119	81416100744	8
M6X/120	81976300196	8
MTX/708	81251016762	7
MTX/708M	81251016772 - 81251016760	7
MTX/709	81251016763	7
MTX/709M	81251016771 - 81251016759	7

MAN TGX

QTC®	OEM	PAG
MTX/100	81416100364	9
MTX/100K	81416100364-81416100369-81416100370	9
MTX/115	81416100369	9
MTX/116	81416100370	9
MTX/180	81416100363	9
MTX/180K	81416100363-81416100369-81416100370	9
MTX/181	81416140025 - 81416140029	9
MTX/182	81416140026 - 81416140030	9
MTX/300	81615100914	10
MTX/301	81615100913	10
MTX/304	81615100916	10
MTX/305	81615100915	10
MTX/309	81615100930	10
MTX/311	81615100929	10
MTX/706	81251016498	9
MTX/706X	81251016516	9
MTX/707	81251016499	9
MTX/707X	81251016515	9
MTX/708	81251016762	9
MTX/708M	81251016772 - 81251016760	9
MTX/709	81251016763	9
MTX/709M	81251016771 - 81251016759	9
MTX/710	81251100084	9
MTX/711	81251100083	9
MTX/722	81251016522	9
MTX/723	81251016521	9
MTX/730	81251100086 - 81251100090	9
MTX/731	81251100085 - 81251100089	9
MXX/183	81416850029	9
MXX/374	81626416080	10
MXX/375	81626416081	10

MAN TGS

QTC®	OEM	PAG
MTS/181	81416140023	11
MTS/182	81416140024 - 81416140028	11
MTS/350	81615100644 - 81615100980	11
MTS/351	81615100643 - 81615100979	11
MXX/356	81615100536	11

MAN TGA XL-XXL		
QTC®	OEM	PAG
MXX/100	81416100305	12
MXX/115	81416100231	12
MXX/116	81416100232	12
MXX/180	81416100306	12
MXX/181	81416100227	12
MXX/182	81416100228	12
MXX/183	81416850029	12
MXX/185	81416850031 - 81416850056	12
MXX/186	81416102881	12
MXX/187	81416102882	12
MXX/188	81416850041	12
MXX/189	81416850040 - 81416850055	12
MXX/201	81611100053	13
MXX/216	81416850053	13
MXX/217	81416850061	13
MXX/260	81624100046	13
MXX/261	81624100047	13
MXX/262	81624100048	13
MXX/263	81624100049	13
MXX/264	81624400041	13
MXX/265	81624400039	13
MXX/300	81615100400-81615100280-81615100404	14
MXX/301	81615100399-81615100281-81615100403	14
MXX/302	81626100024	14
MXX/303	81626100023	14
MXX/304	81615100402-81615100706	14
MXX/305	81615100401-81615100705	14
MXX/306	81626100018	14
MXX/307	81626100019	14
MXX/308	81615100273	14
MXX/309	81615110001	14
MXX/310	81615105187	15
MXX/350	81615100374 - 81615100752 81615100802 - 81615100978	15
MXX/351	81615100333-81615100751-81615100801	15

MAN TGA XL-XXL		
QTC®	OEM	PAG
MXX/352	81615100372-81615100976-81615100312 81615100748 - 81615100798	15
MXX/353	81615100311 - 81615100797 - 81615100747 81615100323-81615100735-81615100979 81615100351 - 81615100643	15
MXX/355	81615100538	15
MXX/356	81615100536 - 81615100823 81615100468 - 81615100822	15
MXX/362G	81661400306-81664100184-81661400310	16
MXX/363	81664100309	16
MXX/363G	81661400307-81664100185-81661400311	16
MXX/370	81615100410	16
MXX/370G	81615100408 - 81615100376	16
MXX/371	81615100411	16
MXX/371G	81615100409 - 81615100377	16
MXX/400	81664106086	17
MXX/400WS		17
MXX/402	81664100294	17
MXX/403	81664100293	17
MXX/415	81664100226	17
MXX/700	81251016448	12
MXX/701	81251016449	12
MXX/702	81251016450	12
MXX/703	81251016451	12
MXX/720	81253206112	12
MXX/720W	81253206114	12
MXX/721	81253206111	12
MXX/721W	81253206113	12
MXX/722	81253206090	12
MXX/723	81253206089	12
MTX/400	81664106606	17
MTX/400WS		17
MTX/401	81664106599	17
MTX/402	81664106625	17
MTX/415	81664400192	17
MTX/445	81664106674	17
MTX/475	81664400187	17

MAN TGA M-L-XL		
QTC®	OEM	PAG
MXX/101	81416105451 - 81416105554 - 81416105664	18
MXX/102	81416105508 - 81416105598 81416105600 - 81416105590	18
MXX/103	81416105507 - 81416105597 81416105599 - 81416105589	18
MML/100	81416100307	19
MML/115	81416100229	19
MML/116	81416100230	19
MML/180	81416100308	19
MML/181	81416100225	19
MML/182	81416100226	19
MML/186	81416102900	19
MML/300	81615100472-81615100278-81615100760	21
MML/301	81615100473-81615100279-81615100759	21
MML/302	81626100020	21 - 22
MML/303	81626100021	21 - 22
MML/304	81615100762 - 81615100598	21
MML/305	81615100761 - 81615100597	21
MML/306	81626100032	21 - 22
MML/307	81626100033	21 - 22
MML/322	81615100420-81615100484-81615100488 81615100588-81615100592-81615100638 81615100856-81615100858-81615100938 81615100419-81615100485-81615100489	22
MML/323	81615100589-81615100593-81615100637 81615100855-81615100857-81615100937 81615100418-81615100482-81615100486	22
MML/324	81615100586-81615100590-81615100640 81615100854-81615100860	22
MML/325	81615100417-81615100483-81615100487 81615100587-81615100591-81615100639 81615100853-81615100859	22
MML/350	81615100382 - 81615100740	20
MML/351	81615100355 - 81615100739	20
MML/352	81615100380-81615100644 - 81516100736	20
MML/353	81615100351-81615100643 - 81516100735	20
MML/355	81615100538 - 81615100822	20
MML/356	81615100823	20
MXX/309	81615110001	21 - 22
MXX/310	81615105187	20

MAN F2000

QTC®	OEM	PAG
F20/100	81416104114	23
F20/102	81416130073	24
F20/104	81416130071	24
F20/105	81416155061	24
F20/110	81960020425	23
F20/111	81416100150	23
F20/112	81416100191	23
F20/113	81416100159	23
F20/114	81416100158	23
F20/115	81416100151	23
F20/116	81416100152	23
F20/122	81416130066	24
F20/123	81416130069	24
F20/130	81416135035	24
F20/132	81416100166	23
F20/133	81416100167	23
F20/135	81416100164	23
F20/142	81416130078	24
F20/143	81416130079	24
F20/146	81416130080	24
F20/147	81416130081	24
F20/200	81611505060	27
F20/201	81611100043	27
F20/205	81748210095	27
F20/260	81624102224	27
F20/261	81624102225	27
F20/262	81624100064	27
F20/263	81624100063	27
F20/300	81612300066	25
F20/301	81612300067	25
F20/304	81612105363	25
F20/305	81612105364	25
F20/310	81615100267	25
F20/311	81615100268	25
F20/312	81615100262	25
F20/313	81615100263	25
F20/315	81615105181	25
F20/316	81615105196	25
F20/317	81615105197	25

MAN F2000

QTC®	OEM	PAG
F20/350	81615100225	25
F20/351	81615100226	25
F20/354	81615100229	25
F20/355	81615100230	25
F20/357	81615105163	25
F20/358	81615105164	25
F20/363	81615105161	25
F20/364	81615105162	25
F20/368	81626406058	26
F20/369	81626406057	26
F20/371	81971006098	26
F20/373	81626410099	26
F20/374	81626410100	26
F20/376	81626410101	26
F20/377	81669120033	25
F20/378	81669120034	25
F20/380	81626004082	26
F20/381	81626004077	26
F20/382	81626806096	26
F20/383	81626806095	26
F20/384	81626800055	26
F20/385	81626806107	26
F20/386	81626806108	26
F20/388	81626306020	26
F20/389	81626306021	26
F20/395	81626416052	26
F20/398	81626300048	26
F20/399	81626300047	26
F20/401	81664100352	25
F20/402	81664100353	25
F20/500	81961210056	27
F20/CH2	81417015344	27
F20/CH3	81417015345	27
F20/CH5	81417226013	27
F20/CH6	81417226012	27

MAN TGL

QTC®	OEM	PAG
MTL/100	81416100309 81416100352	28
MTL/300	81615100274 81615100820 81615100942	28
MTL/301	81615100275 81615100821 81615100941	28
MML/186	81416102900	28
MXX/310	81615105187	28

MAN LE2000

QTC®	OEM	PAG
LE2/180	85416104032 85416104036	29
L20/300	85612100004	29
L20/301	85612100003	29

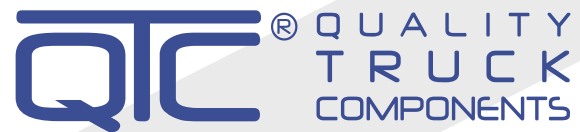

...you'll never drive alone

“I marchi utilizzati in questo catalogo sono proprietà dei fabbricanti dei veicoli industriali e commerciali a cui si riferiscono. Il loro utilizzo su questo catalogo serve unicamente per aiutare ad identificare il modello sul quale deve essere montato il pezzo di ricambio. I nostri articoli, pur non essendo originali, sono perfettamente intercambiabili ai veicoli a cui si riferiscono.”

“The property of the brand names used into this catalogue is exclusively of the makers. Original numbers used are for indication purpose only. Although our products are not original, they are perfectly interchangeable with them. “

“Les marques utilisées dans ce catalogue sont propriété des fabricants de véhicules industriels et commerciaux auxquels ils se réfèrent. Leur utilisation ne serve qu'à identifier le modèle sur lequel doit être montée la pièce de rechange. Nos articles, ne sont pas originaux, mais ils sont adaptables aux véhicules auxquels ils se rapportent “

“Die im vorliegenden Katalog verwendeten Marken sind Eigentum der Hersteller der Industrie- und Nutzfahrzeuge, auf die sie sich beziehen. Ihre Verwendung im vorliegenden Katalog dient ausschliesslich zur Identifizierung des Modells, in dem das Ersatzteil eingebaut werden soll. Unsere Artikel sind zwar keine Originalteile, aber dennoch perfekt austauschbar bei den Fahrzeuge, auf die sie sich beziehen “

“Znaki towarowe użyte w tym katalogu są własnością producentów pojazdów przemysłowych i użytkowych, do których się odnoszą. Numery OE w tym katalogu służą jedynie do właściwej identyfikacji części, oraz modelu w którym ta część zamienna może być zamontowana. Nasze artykuły, choć nie oryginalne, są doskonałe zamiennie z częściami oryginalnymi, do których się odnoszą “

“Τα εμπορικά σήματα που χρησιμοποιούνται σε αυτόν τον κατάλογο είναι ιδιοκτησία των κατασκευαστών των βιομηχανικών και εμπορικών οχημάτων στα οποία αναφέρονται. Η χρήση τους σε αυτόν τον κατάλογο χρησιμεύει μόνο για να βοηθήσει στον προσδιορισμό του μοντέλου στο οποίο πρέπει να τοποθετηθεί το ανταλλακτικό. Τα άρθρα μας, αν και δεν είναι πρωτότυπα, είναι απολύτως ανταλλάξιμα με τα οχήματα στα οποία αναφέρονται. “

“A propriedades das marcas usadas neste catálogo é dos fabricantes dos veículos. Codigos originais são usados apenas para indicação aos nossos clientes. Nossos produtos não são originais, mas perfeitamente intercambiáveis “

“Las marcas especificadas en este catalogo son propiedad de los fabricantes de vehículos industriales y comerciales referidos. El propósito de este catalogo es único y exclusivamente, para identificar el modelo en el cual se monta la pieza de ricambio suministrada por nosotros. Las referencias originales son utilizadas única y exclusivamente para su identificación por parte de nuestros clientes. Nuestros artículos no son originales pero perfectamente intercambiables“